



Jumru

Jumru[®]



Table des Matières

Yamato..... 2

Yamato



Yamato Catcher

Numéro d'article: 29.193

3120151



Yamato Catcher

Numéro d'article: 29.195

3100513

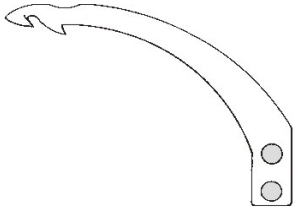

Yamato Catcher

Numéro d'article: 29.183

95 399

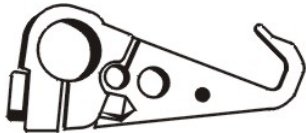

Yamato Knifeholder

Numéro d'article: 30.860

3501534



Yamato Lamé

Numéro d'article: 29.141

CT 68 184 = CT36270

**Yamato Lamé**Numéro d'article: 29.143

CT 68 121 = CT36250

**Yamato Lamé**Numéro d'article: 28.068

CT 37 538

**Yamato Lamé**Numéro d'article: 28.067

CT 37 514

**Yamato Lamé**Numéro d'article: 30.864

CT 35 897

**Yamato Lamé**Numéro d'article: 30.863

CT 3110038

**Yamato Lame**

Numéro d'article: 28.069

CT 30 421

**Yamato Lame**

Numéro d'article: 29.154

CT 20 491 G

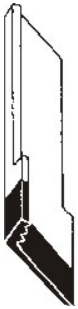
**Yamato Lame**

Numéro d'article: 27.761

CT 20 491

**Yamato Lame**

Numéro d'article: 29.181

95 276 (CT)

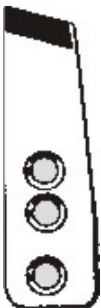
**Yamato Lame**

Numéro d'article: 29.182

94 417 (CT)

**Yamato Lame**

Numéro d'article: 29.140

68 184 SUPER

**Yamato Lame**

Numéro d'article: 29.142

68 121 SUPER

**Yamato Lame**

Numéro d'article: 29.152

CT 35 897

**Yamato Lame**

Numéro d'article: 30.862

3501597 (CT)

**Yamato Lame**

Numéro d'article: 30.861

3501535 (CT)

**Yamato lame**

Numéro d'article: 30.859

3501200**Yamato lame**

Numéro d'article: 30.858

3501032 (CT)**Yamato lame**

Numéro d'article: 27.743

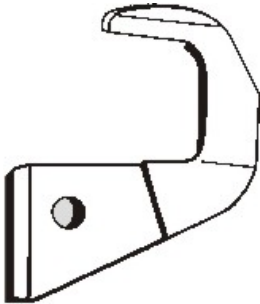
32 914 (CT)**Yamato lame**

Numéro d'article: 29.197

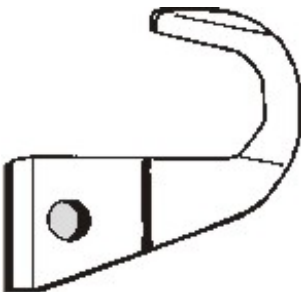
3120015 (CT)**Yamato lame**

Numéro d'article: 29.199

3110037 (CT)



Yamato Lame

Numéro d'article: 30.854

3101802



Yamato Lame

Numéro d'article: 30.853

3101801



Yamato Lame

Numéro d'article: 29.188

3101465 (CT)



Yamato Lame

Numéro d'article: 29.191

3101028 (CT)

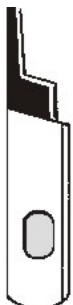

Yamato Lame

Numéro d'article: 29.156

23 580 (CT)

**Yamato Lame**

Numéro d'article: 30.851

212 1235 (CT)

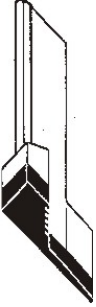
**Yamato Lame**

Numéro d'article: 29.160

212 1107 (CT)

**Yamato Lame**

Numéro d'article: 29.164

211 1056 (CT)

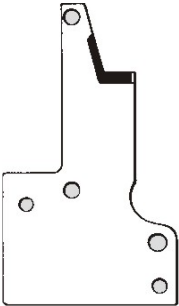
**Yamato Lame**

Numéro d'article: 29.163

211 1055 (CT)

**Yamato Lame**

Numéro d'article: 28.665

2100167 6200097



Yamato Lame

Numéro d'article: 27.762

20496 (CT) 6200022



Yamato Lame

Numéro d'article: 29.155

2020003 (CT)

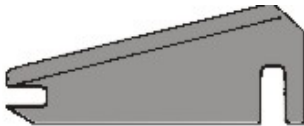

Yamato Lame

Numéro d'article: 29.149

15487 Ceramic



Yamato Lame

Numéro d'article: 30.837

14136 = 21-3003 Eagle



Yamato Lame

Numéro d'article: 30.835

3201062



Yamato Lame

Numéro d'article: 29.194

3120150

**Yamato Lama**

Numéro d'article: 29.198

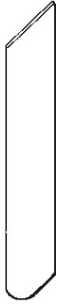
3120016**Yamato Lama**

Numéro d'article: 29.200

3110038**Yamato Lama**

Numéro d'article: 29.189

3101633**Yamato Lama**

Numéro d'article: 29.190

**Yamato Lama**

Numéro d'article: 29.192

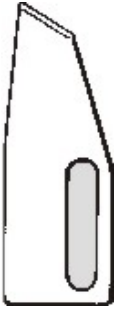
**Yamato Lame**

Numéro d'article: 29.196

3100512**Yamato Lame**

Numéro d'article: 29.161

212 1111**Yamato Lame**

Numéro d'article: 29.158

2110305**Yamato Lame**

Numéro d'article: 29.162

210 1091**Yamato Lame**

Numéro d'article: 29.180

95 277



Yamato Lama

Numéro d'article: 27.738

38 332



Yamato Lama

Numéro d'article: 27.737

37 538



Yamato Lama

Numéro d'article: 27.736

37 514



Yamato Lama

Numéro d'article: 27.758

35 285



Yamato Lama

Numéro d'article: 27.735

30 421

**Yamato Lame**Numéro d'article: 28.664

23 582

**Yamato Lame**Numéro d'article: 27.777

22 195

**Yamato Lame**Numéro d'article: 27.763

20 498

**Yamato Lame**Numéro d'article: 27.760

20 491

**Yamato Lame**Numéro d'article: 30.830

20 271



Yamato Lame Ceramic

Numéro d'article: 30.837

2100167BAK



Yamato Languette

Numéro d'article: 29.145

68 491 = 36240

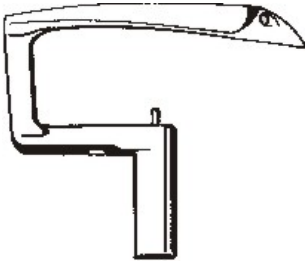

Yamato Looper

Numéro d'article: 28.678

94 480 (93310) (95174)



Yamato Looper

Numéro d'article: 29.144

68 217

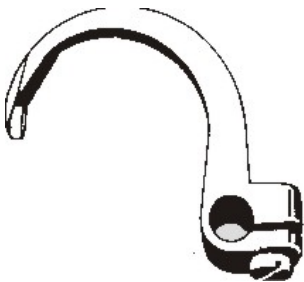

Yamato Looper

Numéro d'article: 29.147

68 124 = 36251 F



Yamato Looper

Numéro d'article: 29.146

68 123 = 36251 E (A)

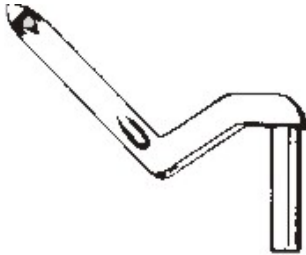

Yamato Looper

Numéro d'article: 27.746

35 227, 32539



Yamato Looper

Numéro d'article: 28.070

34 730, 34599

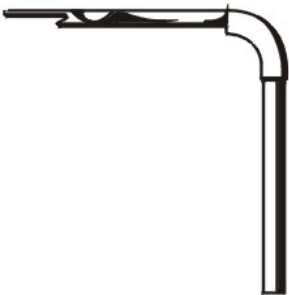

Yamato Looper

Numéro d'article: 30.856

3109310



Yamato Looper

Numéro d'article: 30.855

3109306

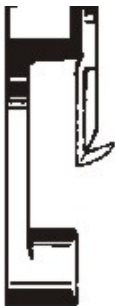

Yamato Looper

Numéro d'article: 30.852

3021092

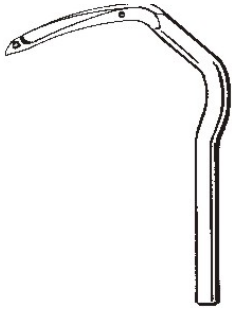
**Yamato Looper**

Numéro d'article: 28.667

25 046 (20378)

**Yamato Looper**

Numéro d'article: 30.850

211 9323 (F4)

**Yamato Looper**

Numéro d'article: 30.849

211 9322 (F3)

Yamato Looper

Numéro d'article: 30.848

211 9305

Yamato Looper

Numéro d'article: 30.847

211 9303

**Yamato Looper**

Numéro d'article: 30.846

211 9302 (Y2)

**Yamato Looper**

Numéro d'article: 30.845

211 9301 (Y1)

**Yamato Looper**

Numéro d'article: 30.844

210 9348

**Yamato Looper**

Numéro d'article: 30.843

210 9347 6209301

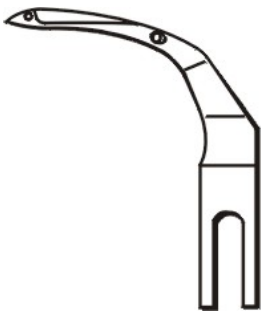
**Yamato Looper**

Numéro d'article: 30.842

210 9335

Yamato Looper

Numéro d'article: 30.841

210 9334



Yamato Looper

Numéro d'article: 29.174

210 9322 6209300



Yamato Looper

Numéro d'article: 30.840

210 9310



Yamato Looper

Numéro d'article: 30.839

2109309

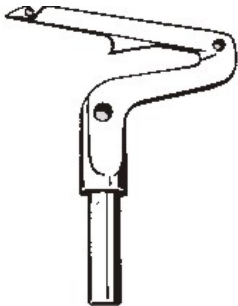

Yamato Looper

Numéro d'article: 29.166

210 9308



Yamato Looper

Numéro d'article: 30.838

210 9307

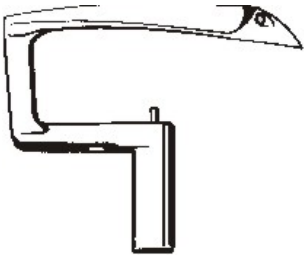

Yamato Looper
Numéro d'article: 30.836
 3209311



Yamato Looper
Numéro d'article: 29.201
 3109300



Yamato Looper
Numéro d'article: 30.834
 212 9300

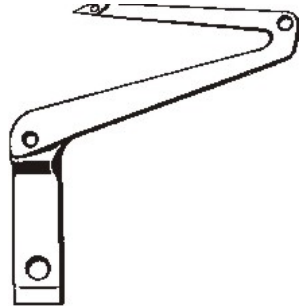

Yamato Looper
Numéro d'article: 30.833
 211 9324

Yamato Looper
Numéro d'article: 30.832
 2109343



Yamato Looper
Numéro d'article: 29.178
 2109342



Yamato Looper

Numéro d'article: 29.177

2109341

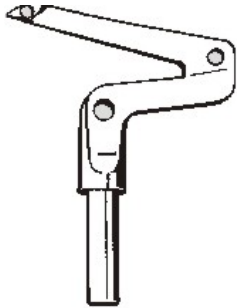

Yamato Looper

Numéro d'article: 29.167

210 9331



Yamato Looper

Numéro d'article: 29.179

210 9328



Yamato Looper

Numéro d'article: 29.176

210 9326



Yamato Looper

Numéro d'article: 29.175

210 9324



Yamato Looper

Numéro d'article: 29.173

210 9320



Yamato Looper

Numéro d'article: 29.172

210 9305

**Yamato Looper**

Numéro d'article: 29.171

210 9304

**Yamato Looper**

Numéro d'article: 29.170

210 9303

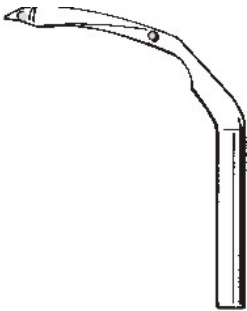
**Yamato Looper**

Numéro d'article: 29.168

210 9302

**Yamato Looper**

Numéro d'article: 29.169

210 9301

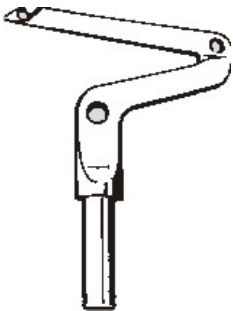
**Yamato Looper**

Numéro d'article: 29.165

210 9300

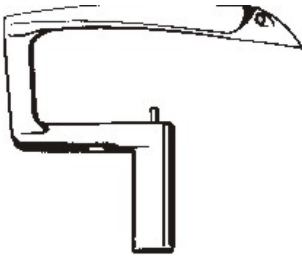

Yamato Looper

Numéro d'article: 28.677

95499



Yamato Looper

Numéro d'article: 29.157

85 168



Yamato Looper

Numéro d'article: 28.656

80 413

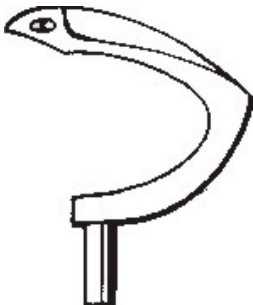

Yamato Looper

Numéro d'article: 29.139

69 086

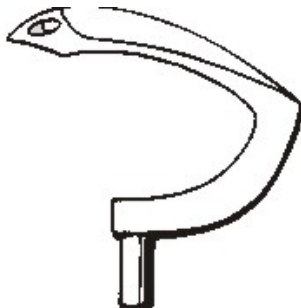

Yamato Looper

Numéro d'article: 29.137

69 085

Yamato Looper

Numéro d'article: 29.138

69 084

**Yamato Looper**

Numéro d'article: 29.185

66 621

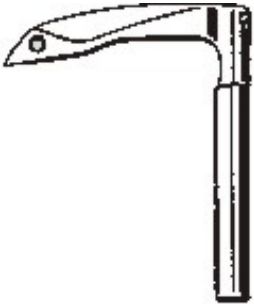
**Yamato Looper**

Numéro d'article: 29.184

66 601

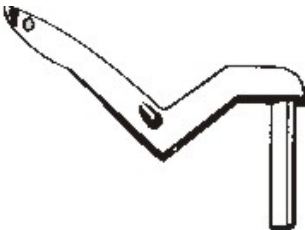
**Yamato Looper**

Numéro d'article: 28.661

34 584

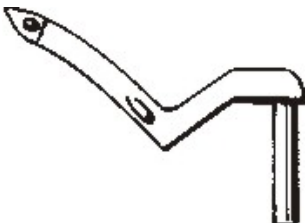
**Yamato Looper**

Numéro d'article: 29.153

34 519

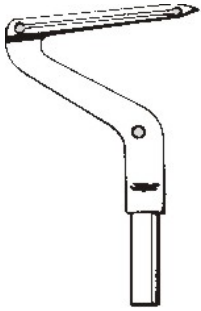

Yamato Looper

Numéro d'article: 27.759

34 393

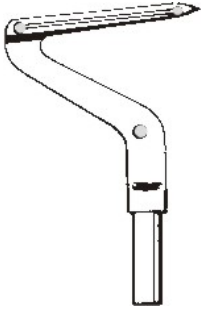

Yamato Looper

Numéro d'article: 34.392

34 392



Yamato Looper

Numéro d'article: 30.831

34 113

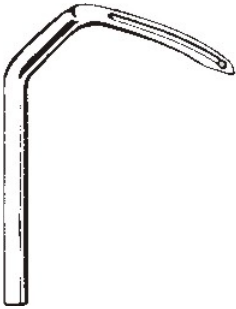

Yamato Looper

Numéro d'article: 27.742

33 059

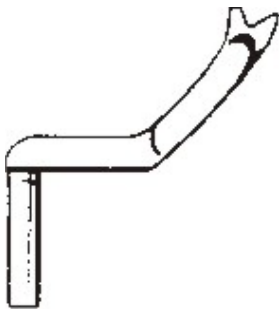

Yamato Looper

Numéro d'article: 27.747

32 813

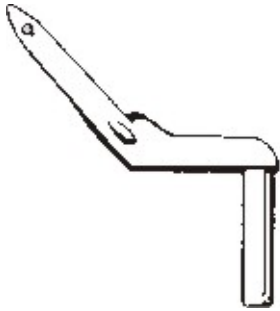
**Yamato Looper**

Numéro d'article: 27.740

32 807

Yamato Looper

Numéro d'article: 28.658

32 790

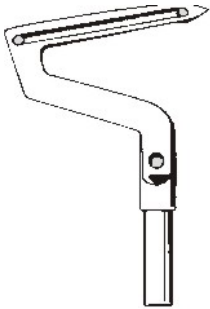
**Yamato Looper**

Numéro d'article: 27.745

32 541

Yamato Looper

Numéro d'article: 27.741

32 415

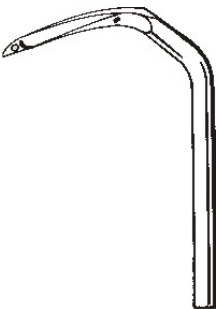
**Yamato Looper**

Numéro d'article: 28.659

31 877

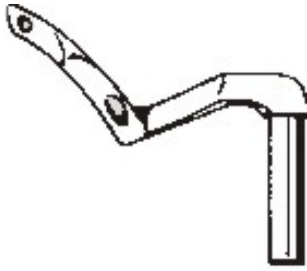

Yamato Looper

Numéro d'article: 28.672

27 013

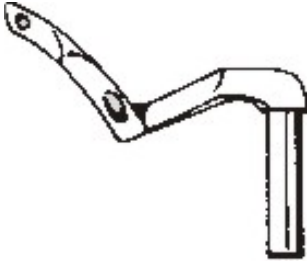

Yamato Looper

Numéro d'article: 28.671

27 012

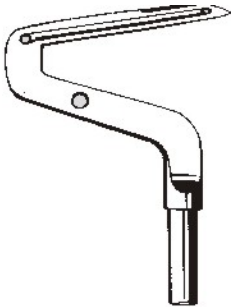

Yamato Looper

Numéro d'article: 27.779

21 757

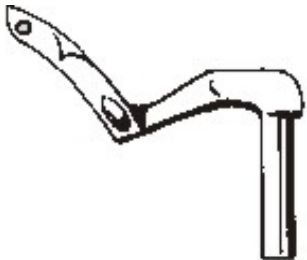

Yamato Looper

Numéro d'article: 28.669

21 756

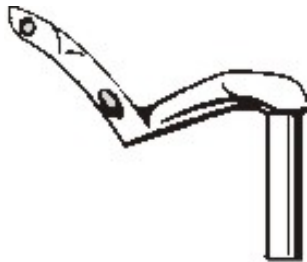

Yamato Looper

Numéro d'article: 28.673

21 754

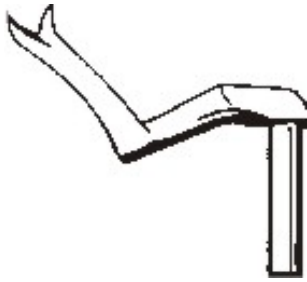
**Yamato Looper**

Numéro d'article: 28.666

21 752

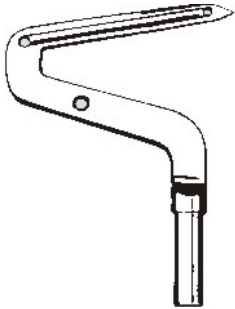
**Yamato Looper**

Numéro d'article: 27.778

21 701

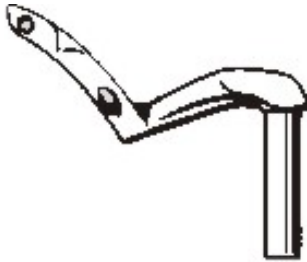
**Yamato Looper**

Numéro d'article: 28.670

21 700

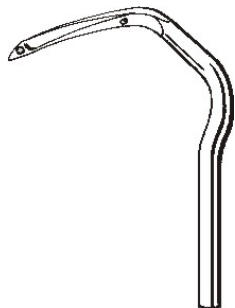
**Yamato Looper**

Numéro d'article: 28.668

20 577

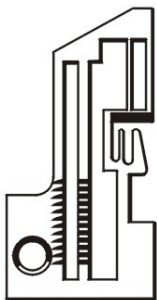
**Yamato Plat**

Numéro d'article: 30.857

33 821

